

# PowerPact® Q-Frame Molded Case Circuit Breakers and Switches (Types QB, QD, QG and QJ)

Catalog  
0734CT0201R1/07

# 07

Class 734



## CONTENTS

Description .....	Page
Description .....	Page 3
Catalog Numbering System .....	Page 4
Overcurrent Protection .....	Page 7
Accessories .....	Page 10
Dimensions .....	Page 12
Trip Curves .....	Page 13



# PowerPact® Q-Frame Molded Case Circuit Breakers and Switches

# PowerPact® Q-Frame Molded Case Circuit Breakers and Switches Description

## Description

The PowerPact® Q-frame line of circuit breakers include QB, QD, QG and QJ molded case circuit breakers and QB automatic switches. They are rated 240 Vac, 250 A max. and are available in lug or bus-connected unit-mount constructions, or I-Line® group-mounted construction.

## Applications

The PowerPact Q-frame circuit breakers are used for overcurrent protection and switching on ac systems. PowerPact Q-frame circuit breakers are rated for 240 Vac (208Y/120 Vac for 3-pole 100 kA) and are available with UL® Listed interruption ratings from 10 kA to 100 kA. Unit-mount circuit breakers are available with lugs on both ends for cabled applications or with mounting studs for bus-mounted applications. These circuit breakers may be mounted in individual enclosures, metering devices, panelboards or switchboards. The I-Line circuit breakers are specifically designed for use in I-Line panelboards and switchboards.

The PowerPact Q-frame circuit breaker is a direct replacement for the Q2 Series device.



PowerPact Q-Frame 2P Unit-Mount Molded Case Circuit Breaker

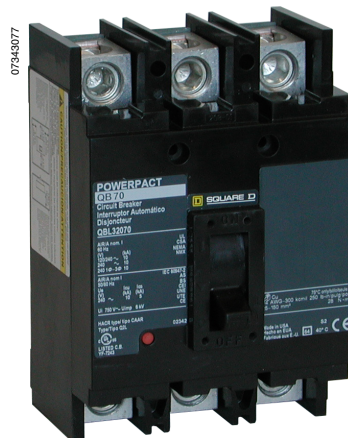

PowerPact Q-Frame 3P Unit-Mount Molded Case Circuit Breaker



PowerPact Q-Frame 2P I-Line Molded Case Circuit Breaker



PowerPact Q-Frame 3P I-Line Molded Case Circuit Breaker

Figure 1: PowerPact Q-Frame Circuit Breakers

# PowerPact® Q-Frame Molded Case Circuit Breakers and Switches Catalog Numbering System

## Catalog Numbering System

**NOTE:** When ordering circuit breakers, catalog number may be collapsed if character is not needed.

**Table 1: Catalog Numbering System for PowerPact® Q-Frame Circuit Breakers**

Number Segment	Character	Description	Q	B	L	3	2	250	4	LW <sup>1</sup>
Circuit Breaker Family	Q									
Circuit Breaker Type (Interrupting Rating)	B	10 kA								
	D	25 kA								
	G	65 kA								
	J	100 kA								
Connection Type	A	I-Line shroud on ON (I) end								
	E	I-Line bolt-on configuration								
	F	No lugs (bus connection)								
	L	Lugs on both ends								
	M	Lugs on ON (I) end only								
Poles	P	Lugs on OFF (O) end only								
	2									
240 V Only	3									
	2									
Continuous Current Rating (A)	70									
	80									
	90									
	100									
	110									
	125									
	150									
	200									
	225									
	250 <sup>2</sup>									
	000 S 22 = Switch (QB only)									
I-Line® Phasing	2-pole	1 = AB								
		2 = AC								
		3 = BA								
		4 = BC								
		5 = CA								
		6 = CB								
	3-pole	None = ABC								
		6 = CBA								
Special Ambient	C	A = 50°C <sup>3</sup>								
Termination Options	T	M = Lugs applied to OFF (O) end; studs with nuts and washers on ON (I) end								
		N = Lugs applied to ON (I) end; studs applied to OFF(O) end								
		P = Studs applied to ON (I) end lugs applied to OFF (O) end								
		S = Studs on both ends (no nuts or washers)								
Control Taps	L	U = Control taps applied to ON (I) end								
		V = Control taps applied to OFF (O) end								
		W = Control taps applied to both ends								
Special Features	Y	D = Calibration test report supplied								
		F = Fungus treatment								
		P = Handle padlock attachment, ON (I) or (OFF) position								
		Q = Handle padlock attachment, OFF (O) position only								

<sup>1</sup> May be multiple options.

<sup>2</sup> 250 A not available in I-Line.

# PowerPact® Q-Frame Molded Case Circuit Breakers and Switches Catalog Numbering System

<sup>3</sup> This rating is not UL or CSA approved

**Table 2: PowerPact® Q-frame Circuit Breaker Catalog Numbers**

Ampere Rating	Fixed AC Magnetic Trip		B Interrupting 10 kA		D Interrupting 25 kA		G Interrupting 65 kA		J Interrupting 100 kA <sup>1</sup>	
	Hold	Trip	Unit-Mount	I-Line®	Unit-Mount	I-Line®	Unit-Mount	I-Line®	Unit-Mount	I-Line®
<b>2P, 240 Vac</b>										
70 A	1000 A	1800 A	QBL22070	QBA22070	QDL22070	QDA22070	QGL22070	QGA22070	QJL22070	QJA22070
80 A	1000 A	1800 A	QBL22080	QBA22080	QDL22080	QDA22080	QGL22080	QGA22080	QJL22080	QJA22080
90 A	1000 A	1800 A	QBL22090	QBA22090	QDL22090	QDA22090	QGL22090	QGA22090	QJL22090	QJA22090
100 A	1200 A	2400 A	QBL22100	QBA22100	QDL22100	QDA22100	QGL22100	QGA22100	QJL22100	QJA22100
110 A	1200 A	2400 A	QBL22110	QBA22110	QDL22110	QDA22110	QGL22110	QGA22110	QJL22110	QJA22110
125 A	1200 A	2400 A	QBL22125	QBA22125	QDL22125	QDA22125	QGL22125	QGA22125	QJL22125	QJA22125
150 A	1200 A	2400 A	QBL22150	QBA22150	QDL22150	QDA22150	QGL22150	QGA22150	QJL22150	QJA22150
175 A	1200 A	2400 A	QBL22175	QBA22175	QDL22175	QDA22175	QGL22175	QGA22175	QJL22175	QJA22175
200 A	1200 A	2400 A	QBL22200	QBA22200	QDL22200	QDA22200	QGL22200	QGA22200	QJL22200	QJA22200
225 A	1200 A	2400 A	QBL22225	QBA22225	QDL22225	QDA22225	QGL22225	QGA22225	QJL22225	QJA22225
250 A <sup>2</sup>	1200 A	2400 A	QBL22250	—	QDL22250	—	QGL22250	—	QJL22250	—
<b>3P<sup>3</sup>, 240 Vac</b>										
70 A	1000 A	1800 A	QBL32070	QBA32070	QDL32070	QDA32070	QGL32070	QGA32070	QJL32070	QJA32070
80 A	1000 A	1800 A	QBL32080	QBA32080	QDL32080	QDA32080	QGL32080	QGA32080	QJL32080	QJA32080
90 A	1000 A	1800 A	QBL32090	QBA32090	QDL32090	QDA32090	QGL32090	QGA32090	QJL32090	QJA32090
100 A	1200 A	2400 A	QBL32100	QBA32100	QDL32100	QDA32100	QGL32100	QGA32100	QJL32100	QJA32100
110 A	1200 A	2400 A	QBL32110	QBA32110	QDL32110	QDA32110	QGL32110	QGA32110	QJL32110	QJA32110
125 A	1200 A	2400 A	QBL32125	QBA32125	QDL32125	QDA32125	QGL32125	QGA32125	QJL32125	QJA32125
150 A	1200 A	2400 A	QBL32150	QBA32150	QDL32150	QDA32150	QGL32150	QGA32150	QJL32150	QJA32150
175 A	1200 A	2400 A	QBL32175	QBA32175	QDL32175	QDA32175	QGL32175	QGA32175	QJL32175	QJA32175
200 A	1200 A	2400 A	QBL32200	QBA32200	QDL32200	QDA32200	QGL32200	QGA32200	QJL32200	QJA32200
225 A	1200 A	2400 A	QBL32225	QBA32225	QDL32225	QDA32225	QGL32225	QGA32225	QJL32225	QJA32225
250 A <sup>2</sup>	1200 A	2400 A	QBL32250	—	QDL32250	—	QGL32250	—	QJL32250	—

<sup>1</sup> 3P circuit breakers are rated 65 kA at 240/120 Vac, 3Ø, 4-wire delta or 100 kA at 208Y/120 Vac, 3Ø, 4-wire.

<sup>2</sup> 250 A is based on copper cable only.

<sup>3</sup> On 3P I-Line circuit breakers, add a 6 at the end of the catalog number to indicate CBA jaw configuration. Nothing added indicates a standard ABC jaw configuration.

# PowerPact® Q-Frame Molded Case Circuit Breakers and Switches

## Catalog Numbering System

### Terminations

#### Lug Configuration

Position three of the catalog number indicates the general lug configuration of the circuit breaker. PowerPact® Q-frame circuit breakers have box-type lugs suitable for use with 4 AWG–300 kcmil (21–150 mm<sup>2</sup>) aluminum or copper conductors. The 250 A circuit breaker allows copper conductors only.

- A = I-Line® shroud on ON (I) end
- L = Lugs on both ends
- P = Lugs on OFF (O) end only
- E = I-Line bolt-on configuration
- M = Lugs on ON (I) end only
- F = No lugs (bus connection)

#### Special Terminations

Special terminal arrangements may be called out in the catalog number by adding a two-digit code following the ampere rating. The first digit of the special terminal code is always the letter “T”.

- TS = Studs on both ends (no nuts or washers)
- TN = Studs on OFF (O) end only (no nuts or washers)
- TP = Studs on ON (I) one only (no nuts or washers)
- TM = Studs on ON (I) end with nuts and washers

#### Control Wire Taps

Circuit breakers with control taps are identified in the catalog number through a two-digit code in the suffix. The first digit of the control tap code is always the letter “L”.

- LU = Control taps applied to ON (I) end
- LV = Control taps applied to OFF (O) end
- LW = Control taps applied to both ends

#### Special Features

Circuit breakers with special features are identified in the catalog number with a two-digit code following the ampere rating. The first digit of the special feature code is always the letter “Y”.

- YD = Calibration test report supplied
- YF = Fungus treatment
- YP = Handle padlock attachment, OFF (O) or ON (I) position
- YQ = Handle padlock attachment, OFF (O) position only

Other special terminations and special features are available. Contact the local Field Sales office for more information.

#### Multiple Options

When multiple options are required, they should be applied in the following order:

C—50°C ambient

T—Special terminations

L—Lug options

Y—Special options

## Overcurrent Protection

PowerPact® Q-frame circuit breakers contain individual thermal (overload) and magnetic (short circuit) sensing elements in each pole. The amperage ratings of the thermal trip elements are calibrated at 40°C (104°F) free air ambient temperature. Per the National Electric Code® (NEC®) circuit breakers may only be applied at up to 80% of their rating.

### Operating Mechanism

PowerPact Q-frame circuit breakers have an over-center toggle mechanism providing quick-make, quick-break operation. The operating mechanism is also trip-free, which allows tripping even when the circuit breaker handle is held in the ON (I) position. An internal cross bar provides common opening and closing of all poles with a single operating handle.

All PowerPact Q-frame circuit breakers have an integral push-to-trip button in the cover to manually trip the circuit breaker. This should be used as part of a regular preventive maintenance program.

### Trip Indication

The PowerPact Q-frame circuit breaker handle can assume any of three positions, ON (I), tripped, or OFF (O) as shown in Figure 2.

The center tripped position provides positive visual indication that the circuit breaker has tripped. The circuit breaker can be reset by first pushing the handle to the extreme OFF (O) position. Power can then be restored to the load by pushing the handle to the ON (I) position.

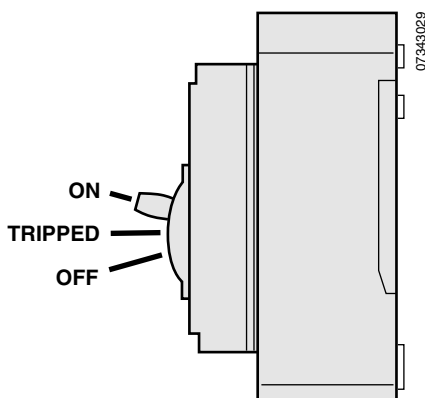

**Figure 2: Handle Position**

### Standards

PowerPact Q-frame circuit breakers are built in accordance with UL Standard 489 and NEMA Standard AB-1-1999. Circuit breakers are UL Listed for use in the United States and UL approved for use in Canada under File E84905 and Canadian Standard C22.2 No. 5-02. Circuit breakers are ANCE listed under Mexican ANCE Standard NMX-J-266-ANCE-2002. Molded case switches are UL Listed under UL File 33117, approved for use in the United States and Canada.

# PowerPact® Q-Frame Molded Case Circuit Breakers and Switches

## Overcurrent Protection

### Interrupting Ratings

**Table 3: Circuit Breaker Interrupting Ratings**

Catalog Prefix	Ampere Rating		Number of Poles	UL Listed Interrupting Rating		Federal Specification (W-C-375B/GEN)
	Unit Mount	I-Line®		208/120 Vac	240 Vac	
QB	70–250 A	70–225 A	2	10 kA	10 kA	12b
			3	10 kA	10 kA	12b
QD	70–250 A	70–225 A	2	25 kA	25 kA	14b
			3	25 kA	25 kA	14b
QG	70–250 A	70–225 A	2	65 kA	65 kA	15b
			3	65 kA	65 kA	15b
QJ	70–250 A	70–225 A	2	100 kA	100 kA	15b
			3	100 kA	—	—

### Molded Case Switches

Two-pole (QB\_2000S22) and three-pole (QB\_32000S22) automatic molded case switches are available with a 225 A, 240 Vac, 10 kA rating. Automatic molded case switches contain magnetic tripping elements set high enough not to interfere with normal overload protective device operation but still protect the switch in the event of a short circuit. For Q-frame switches, this trip point is 4500 A. Molded case switches provide no other overcurrent protection and must be protected by an upstream circuit breaker or fuse.

### Summary of Specifications

**Table 4: Specifications for UL and CSA Rated Q-Frame Circuit Breakers and Switches**

Specification		Molded Case Circuit Breaker	Automatic Switch
Poles		2P and 3P	2P and 3P
Operating Voltage		240 Vac (208Y/120 for 3P at 100 kA)	240 Vac
Current Rating	Unit Mount	70–250 A	70–225 A
	I-Line	70–225 A	70–225 A
Rated Frequency		50–60 Hz	50–60 Hz
Interrupting Rating	QB	10 kA	10 kA
	QD	25 kA	—
	QG	65 kA	—
	QJ	100 kA	—
Certification Standards	UL489	File E84905	File 33117
	NEMA	AB-1-1999	
	CSA C22.2 No. 5-02	File E84905	File 33117
	ANCE	NMX-J-266-ANCE-2002	NMX-J-266-ANCE-2002
Mounting		Unit Mount and I-Line	Unit Mount and I-Line
Connectors	Lugs	4 AWG–300 kcmil (25–150 mm <sup>2</sup> )	4 AWG–300 kcmil (25–150 mm <sup>2</sup> )
	Studs	1/4 - 20	1/4 - 20
	I-Line	Plug-on and Bolt-on	Plug-on and Bolt-on
Connection		Forward or Reverse Fed	Forward or Reverse Fed
Temperature		40°C (104°F)	40°C (104°F)
Endurance Rating	C/O Cycle	1000 load, 5000 no load (6000 total)	1000 load, 5000 no load (6000 total)

## PowerPact® Q-Frame Molded Case Circuit Breakers and Switches Overcurrent Protection

**Table 5: IEC Declared Ratings**

Standards	Molded Case Circuit Breakers	Automatic Switches
Certification Standards	IEC 60947-2—1995 + A1:1997 + A2:2001	IEC 60947-2, Appendix L
Poles	2P and 3P	2P and 3P
Rated Current In	225 A	225 A
Rated Operational Voltage Ue	IEC 415Y/240 Vac	IEC 415Y/240 Vac
Rated Insulation Voltage Ui	750 Vac	750 Vac
Overcurrent Protection Device	—	Requires equivalent 225 A circuit breaker
Rated Conditional Short Circuit Current Icc	—	10 kA
Instantaneous Tripping Current Ii	—	2.5 kA
Rated Frequency	50-60 Hz	50–60 Hz
Rated Ultimate Short Circuit Breaking Capacity Ics	Icu = 10 kA	—
Rated Service Short Circuit Breaking Capacity Ics	50% of Icu	—
Classification	—	X
Connection Method	Forward or Reverse	Forward or Reverse
Suitable for Isolation	Yes (without padlock attachment)	Yes (without padlock attachment)
Impulse Voltage	6 kV	6 kV

## Accessories

### Handle Padlock Attachment

The handle lock-off padlock attaches to the circuit breaker escutcheon for the two- or three-pole applications. The QBPA and QBPAL handle padlock attachments allow locking the handle in the ON (I) or OFF (O) position. The QBPAF and QOBPAFL handle padlock attachments allow locking in the OFF (O) position only. They are intended for use with the QBMIK mechanical interlock kit.

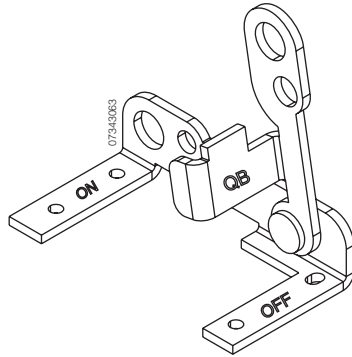

**Figure 3: Handle Padlock Attachment QBPA**

### Mechanical Interlocks

The QBMIK mechanical interlock kit is used with two circuit breakers to allow only one circuit breaker at a time to be in the ON (I) position.

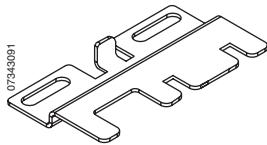

**Figure 4: Mechanical Interlock Attachment QBMIK**

**Table 6: Handle Padlocking Devices for Q-Frame Circuit Breakers**

Attachment Kit	Function
QBPA	Locks OFF (O) or ON (I)
QBPAF	Locks OFF (O) only
QBPAL <sup>1</sup>	Locks OFF (O) or ON (I), left-hand side of handle only
QBPAFL <sup>1</sup>	Locks OFF (O) only, left-hand side of handle only
QBMIK	Allows only one circuit breaker to be turned ON (I) at a time

<sup>1</sup> The QBPAL and QBPALF handle padlocking devices mount on the left-hand side of the handle and are used with the circuit breaker mechanical interlock kit.

For further information refer to the following catalogs:

Catalog Title	Class
Enclosed Circuit Breakers	Class 1131
NQOD Panelboards	Class 1630
I-Line® Panelboards	Classes 2110, 2120

# PowerPact® Q-Frame Molded Case Circuit Breakers and Switches Accessories

## Lug Options

**Table 7: Lug Connector Combinations**

Connector Type	Usage	Configuration
Standard I-Line® Connection	ON (I) end only	
Bolt-on I-Line Connection	ON (I) end only	
Lug Connection	ON (I) and/or OFF (O) end	
Terminal Stud Connection	ON (I) and/or OFF (O) end	
Terminal Stud with Nut and Washer	ON (I) end only	
Bus Connection	ON (I) end only	
Control Tap Connection	ON (I) and/or OFF (O) end	

# PowerPact® Q-Frame Molded Case Circuit Breakers and Switches

## Dimensions

### Dimensions

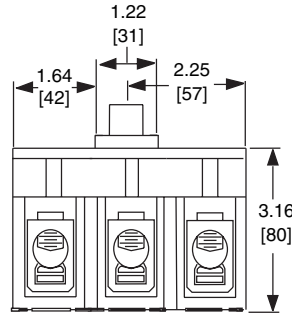
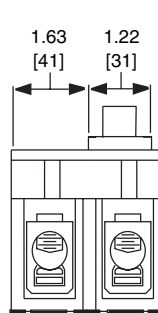
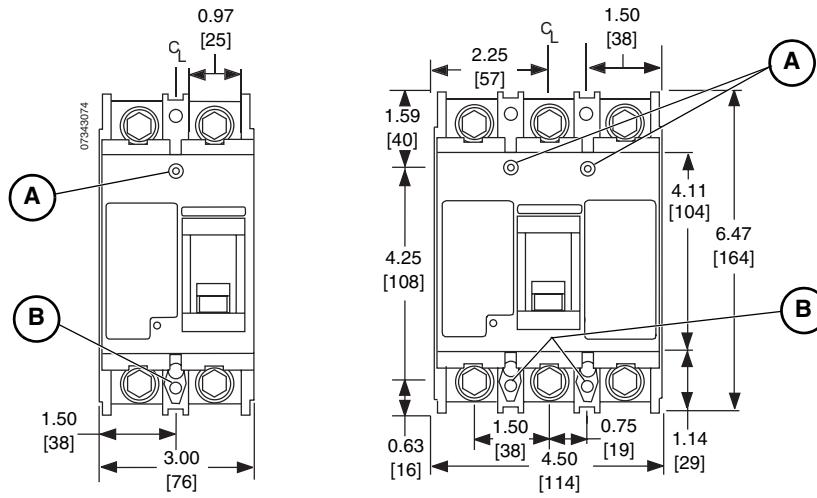

**A** Mounting holes for screw size 8-32 x 3.062 in. UNC.

**B** Mounting holes for screw size 8-32 x 2.062 in. UNC.

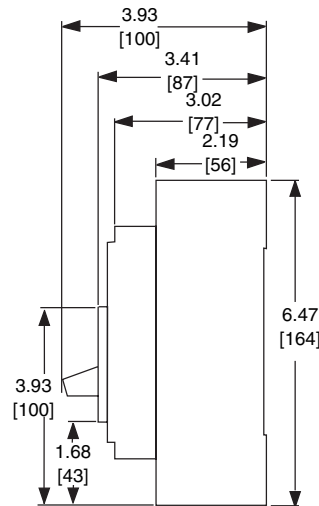

Dimensions: in. mm

# PowerPact® Q-Frame Molded Case Circuit Breakers and Switches Trip Curves

## Trip Curves

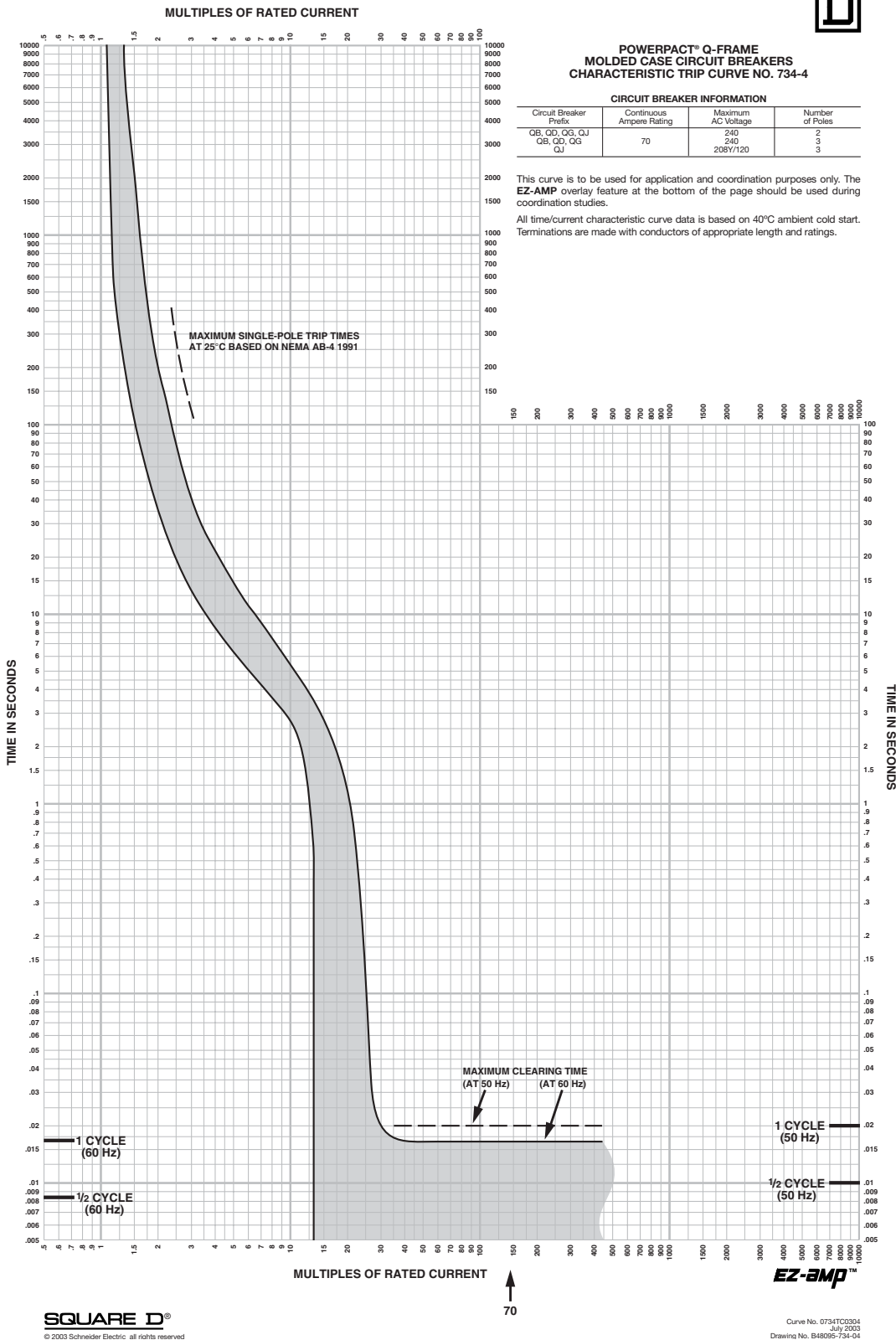

**SQUARE D®**  
© 2003 Schneider Electric all rights reserved

# PowerPact® Q-Frame Molded Case Circuit Breakers and Switches Trip Curves

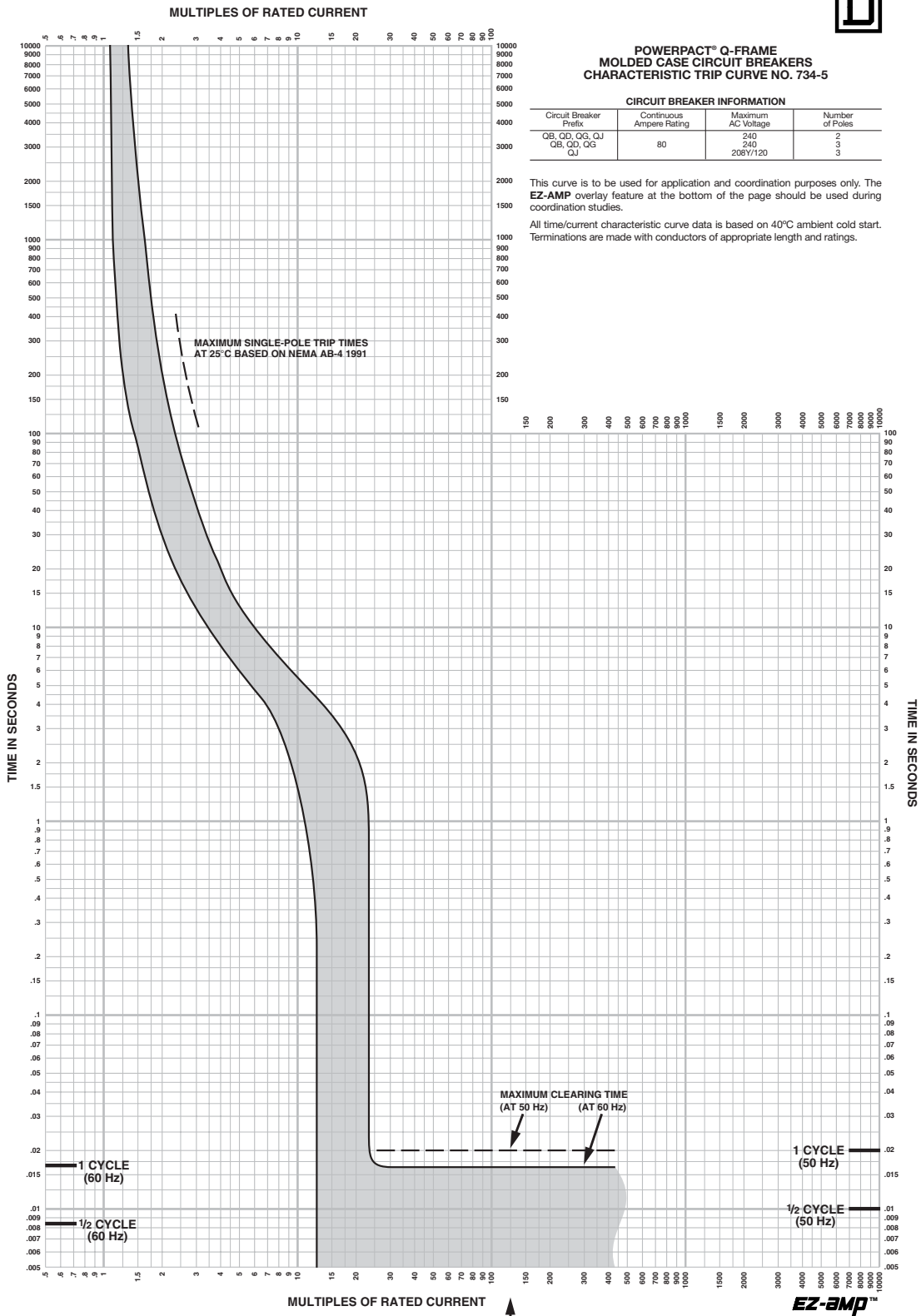

## POWERPACT® Q-FRAME MOLDED CASE CIRCUIT BREAKERS CHARACTERISTIC TRIP CURVE NO. 734-5

### CIRCUIT BREAKER INFORMATION

Circuit Breaker Prefix	Continuous Ampere Rating	Maximum AC Voltage	Number of Poles
QB, QD, QG, QJ	80	240	2
QB, QD, QG, QJ		240	3
QJ		208V/120	3

This curve is to be used for application and coordination purposes only. The EZ-AMP overlay feature at the bottom of the page should be used during coordination studies.

All time/current characteristic curve data is based on 40°C ambient cold start. Terminations are made with conductors of appropriate length and ratings.

**SQUARE D®**  
© 2003 Schneider Electric. All rights reserved.

Curve No. 0734TC0305  
July 2003  
Drawing No. B48095-734-06

# PowerPact® Q-Frame Molded Case Circuit Breakers and Switches Trip Curves

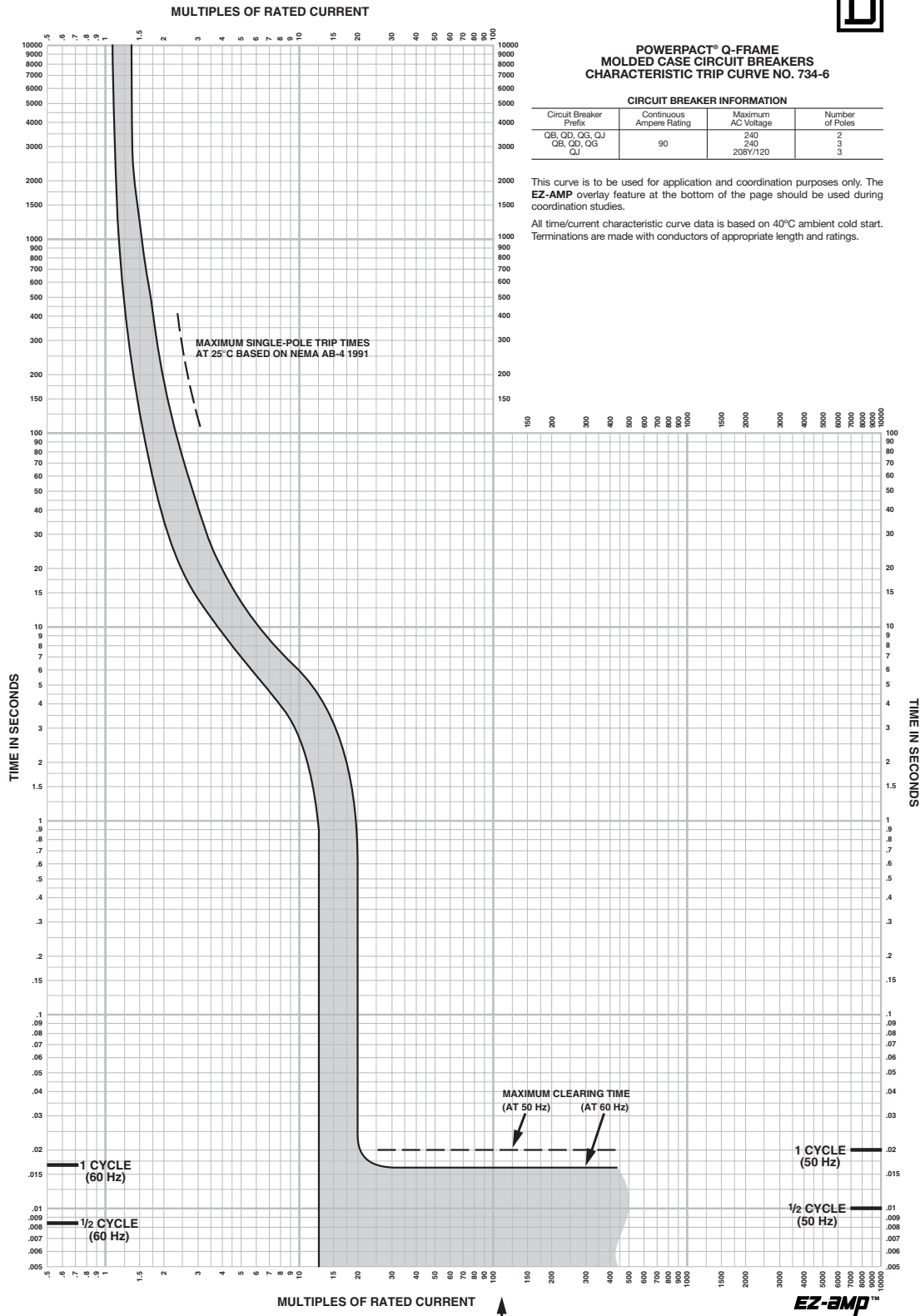

**POWERPACT® Q-FRAME  
MOLDED CASE CIRCUIT BREAKERS  
CHARACTERISTIC TRIP CURVE NO. 734-6**

**CIRCUIT BREAKER INFORMATION**

Circuit Breaker Prefix	Continuous Ampere Rating	Maximum AC Voltage	Number of Poles
QB, OD, OG, OJ	90	240	2
Q8, QD, QG, QJ		240 208V/120	3

This curve is to be used for application and coordination purposes only. The EZ-AMP overlay feature at the bottom of the page should be used during coordination studies.  
All time/current characteristic curve data is based on 40°C ambient cold start. Terminations are made with conductors of appropriate length and ratings.

**SQUARE D®**  
© 2003 Schneider Electric all rights reserved

Curve No. 0734TC0306  
July 2003  
Drawing No. B48095-734-05

# PowerPact® Q-Frame Molded Case Circuit Breakers and Switches Trip Curves

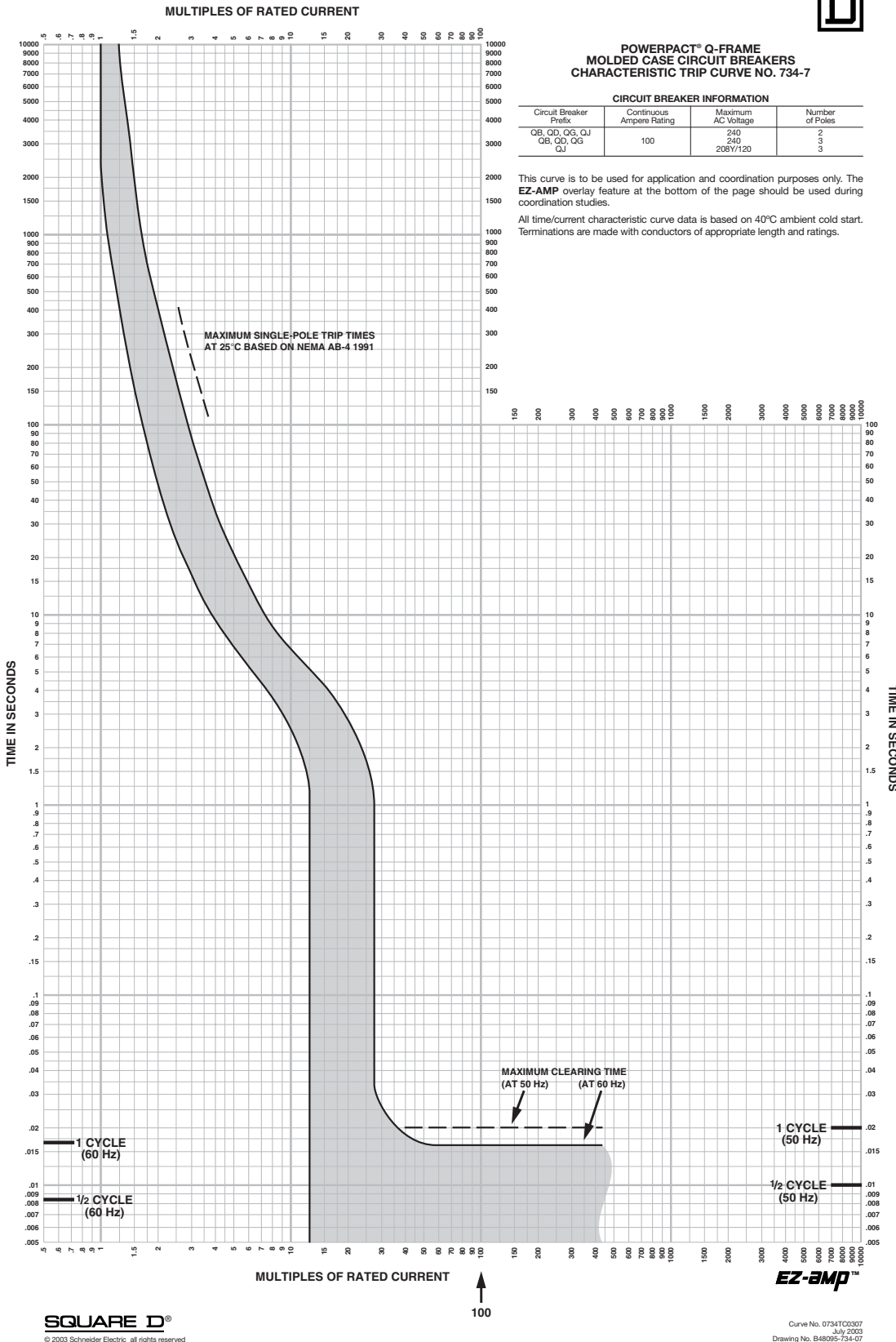

# PowerPact® Q-Frame Molded Case Circuit Breakers and Switches Trip Curves

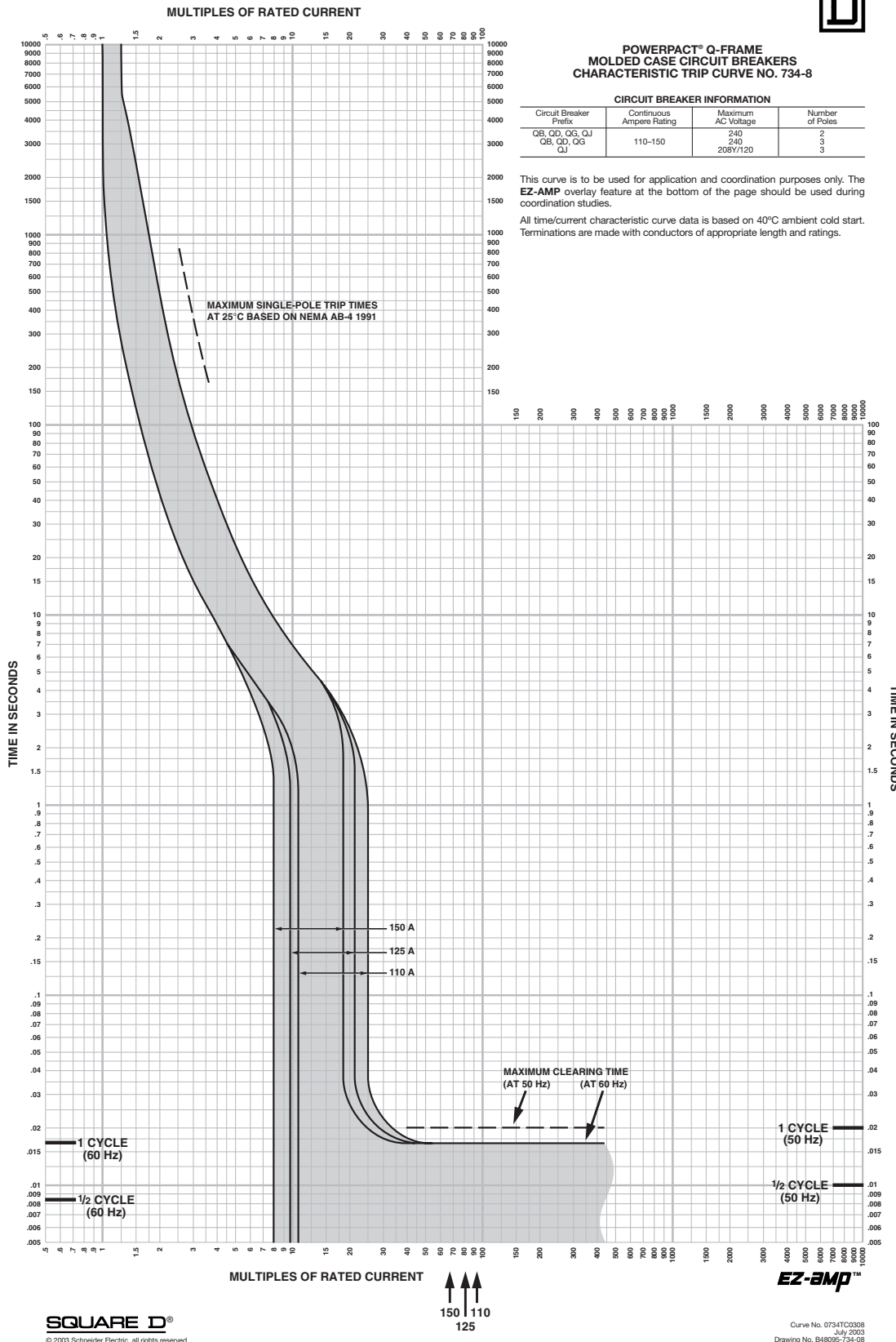

# PowerPact® Q-Frame Molded Case Circuit Breakers and Switches Trip Curves

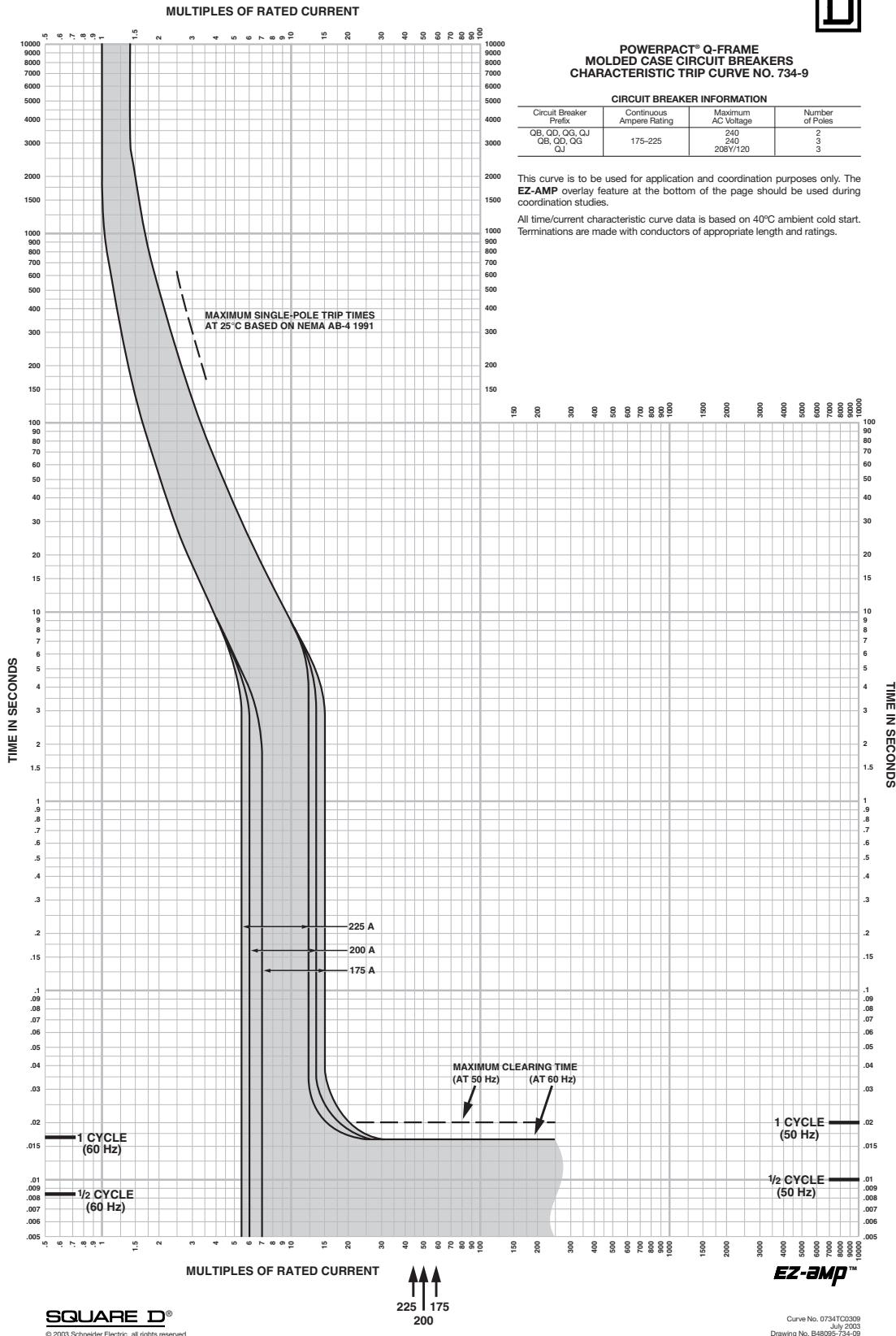

# PowerPact® Q-Frame Molded Case Circuit Breakers and Switches Trip Curves

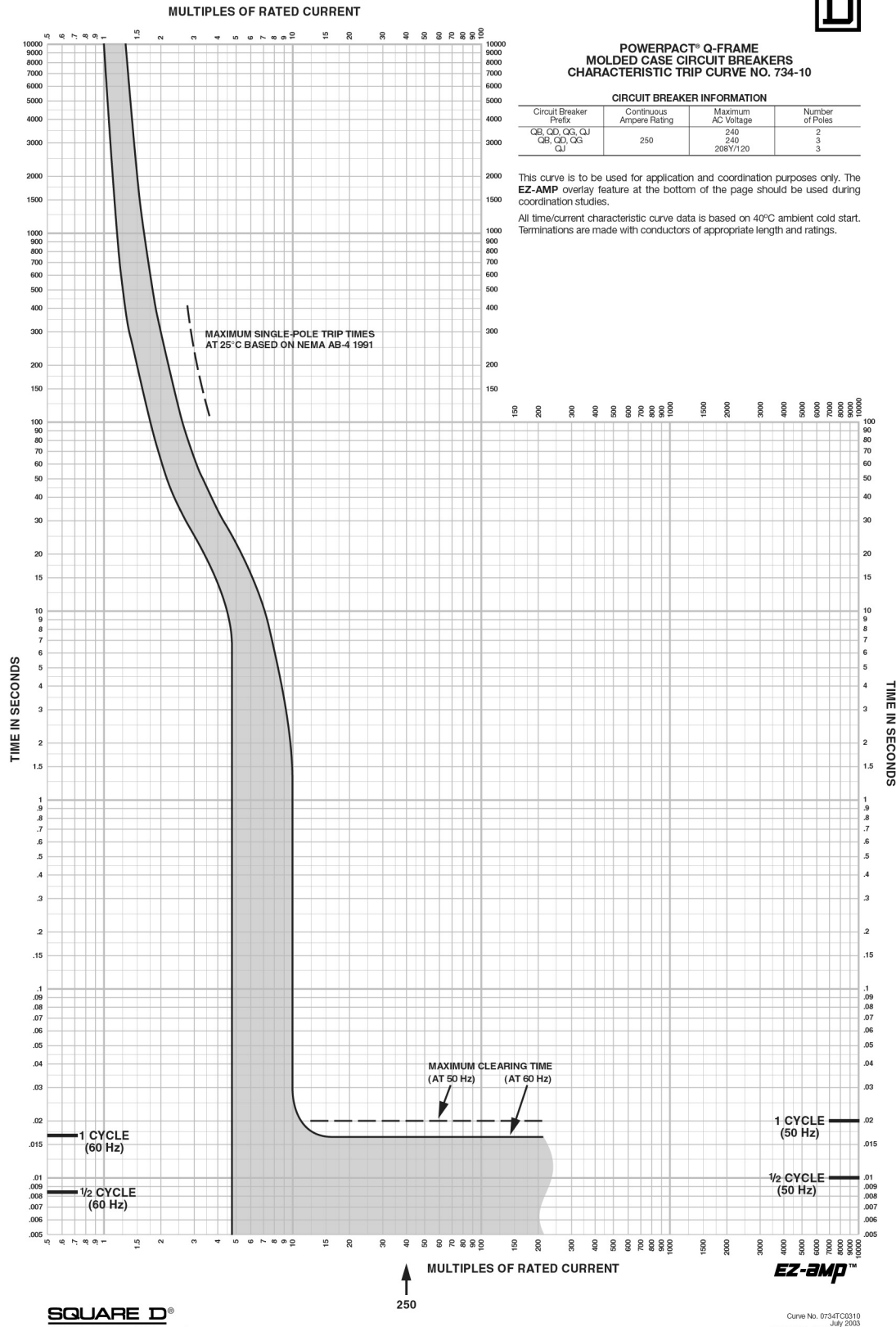

**SQUARE D®**  
© 2003 Schneider Electric. All rights reserved.

Curve No. 0734TC0310  
July 2003  
Drawing No. B48005-734-10

